

Ultra Soft Shield 7400

For doors and panels, where very low closure force is required

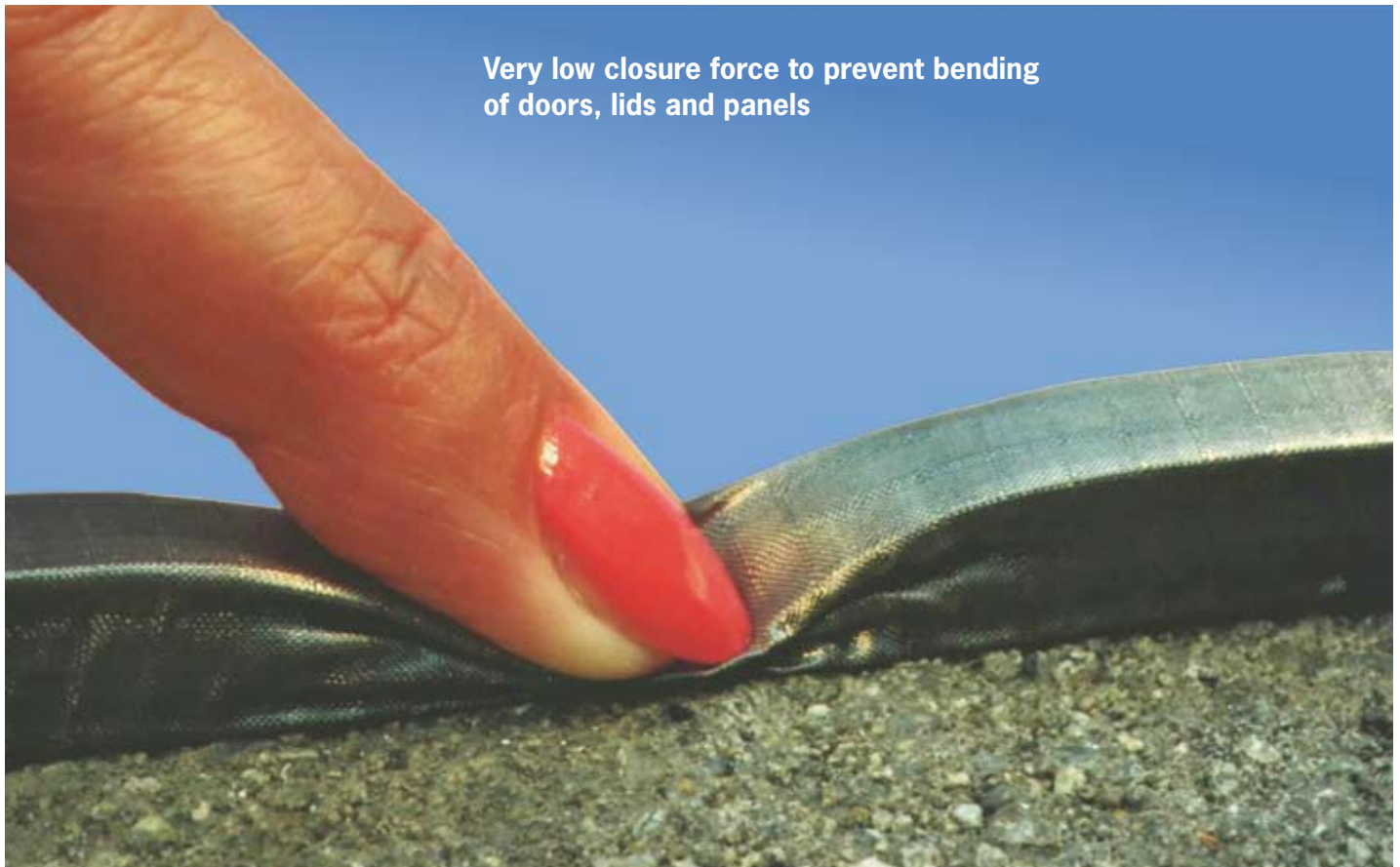
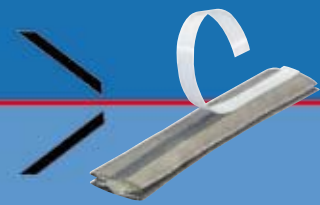

Very low closure force to prevent bending of doors, lids and panels

Ultra Soft Shield 7400 is an HF shielding gasket with high shielding performance and extremely low closure force. This prevents deflection of doors/parts, which improves shielding effectiveness.

The core consists of a high-grade polyurethane foam core with a maximum compression of 80%, which distinguishes Ultra Soft Shield 7400 from other commonly used shielding materials.

Ultra Soft Shield 7400 is covered with a highly conductive, wear and tear resistant metallized fabric.

Different foam cores, conductive foils and fabrics are available for special applications.

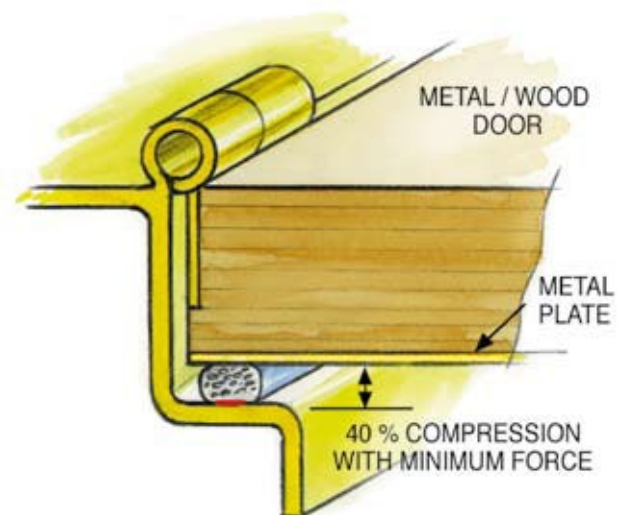

Shielding Performance

Frequency Hz	Mode	Screening dB
1M	E	115
10M	E	108
100M	E	102
400M	E	92
1G	P	90
10G	P	87

Shielding effectiveness depends on surface, shape of gaskets and material used.

See Guarantee

Mechanical properties

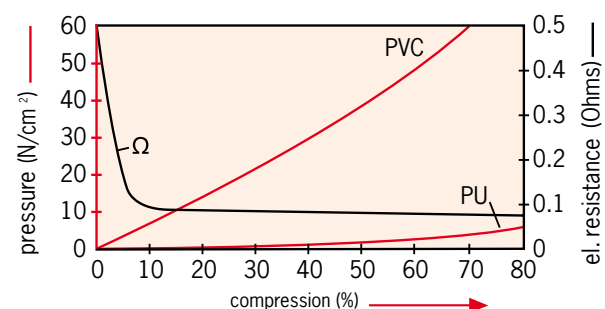

Ultra Soft Shield 7400

For doors and panels, where very low closure force is required

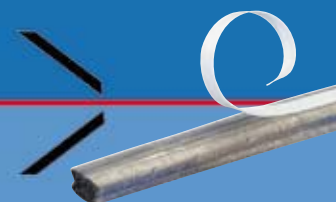

Benefits

- Deflection up to 80%
- Very low closure force
- Very high electric conductivity
- High shielding performance
- Roll lengths 50, 100, 250 or 1000 m
- Easy to fit, self-adhesive
- High abrasion resistance
- Tools required: a pair of scissors

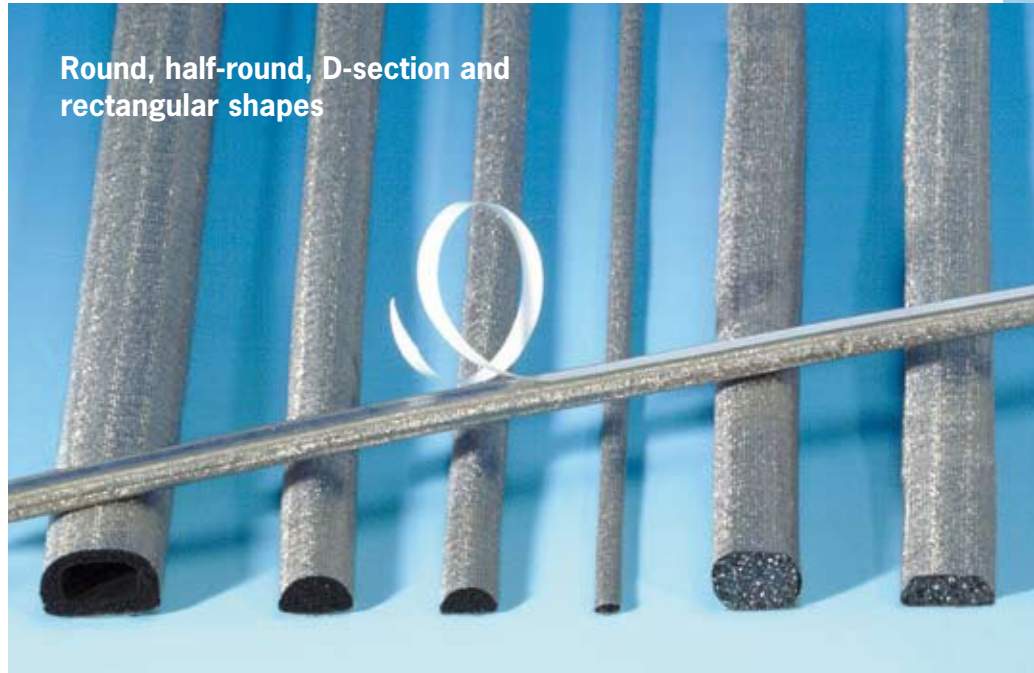

Round, half-round, D-section and rectangular shapes

Dimensions

		Width X (mm)									
Height Y (mm)		4	5	6	9	10	12	15	18	20	25
	3		7443	7453	7463	7493	74103	74123	74153	74183	74203
4		7444	7454	7464	7494	74104	74124	74154	74184	74204	74254
6				7466	7496	74106	74126	74156	74186	74206	74256
8					7488	74108	74128	74158	74188	74208	74258
9					7499	74109	74129	74159	74189	74209	74259
10						741010	741210	741510	741810	742010	742510
12							741212	741512	741812	742012	742512
15								741515	741815	742015	742515
18									741818	742018	742518
20										742020	742520
25											742525

Item numbers in **bold** are 98% stock items. Other dimensions on request.

EPDM rubber	740072	740068	740058	740064	740076	740051
Y x X mm	2 x 4 mm	3 x 6 mm	4 x 8 mm	8 x 12 mm	10 x 12 mm	16 x 20 mm
Y x X inch	.079" x .157"	.118" x .236"	.157" x .315"	.315" x .472"	.394" x .472"	16 x 20 mm

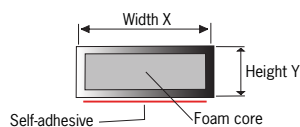

Example

Ultra Soft Shield 7400, 9 x 6 mm, standard self-adhesive, placed in the middle, standard polyurethane foam core: **7496-01-P**

Ordering information

Options

- Cut into specific lengths
- Combination with water seal
- UL94V-0 flame retardant foam core
- Chemical resistant rubbers like EPDM
- Silicone sponge for high temperatures up to 220°C
- Different conductive foils and fabrics

Part number	Tape code	Foam code
7496	01	P

- 01** : standard self-adhesive placed in the middle
- 02** : without self-adhesive
- 03** : with conductive self-adhesive (only recommended on small sizes)
- 06** : standard self-adhesive, asymmetrical

- P** : Standard polyurethane foam
- F** : flame retardant UL94V-0 foam